

INFORMAZIONI TECNICHE

Altezza (in mm) :	27.5
Categoria :	A soffiatti
Corsa :	11 mm
Diametro del collo interno :	8 mm
Diametro labbro :	33.5 mm
Forma :	1,5 soffiatti
Forza orizzontale :	39 N
Forza verticale :	19.5 N
Gamma :	Ventosa
Massa :	6.40 g
Numero di soffiatti :	1,5 soffiatti
Serie :	1
Volume :	6.51 cm ³

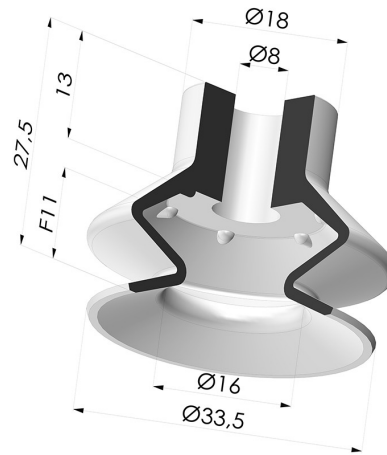

Varianti:

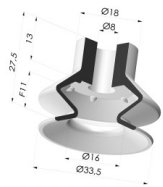

Riferimento variante:
1 33MNT A

- Colore: Bordeaux
- Durezza Shore: SH 60
- Materiale: Antialone



Riferimento variante:
1 33PU A

- Colore: Blu
- Durezza Shore: SH 60
- Materiale: Poliuretano



Riferimento variante:
1 33SL A

- Colore: Rosso Certificato alimentare CE
- Durezza Shore: SH 60
- Materiale: Silicone



Riferimento variante:
1 33SLT A

- Colore: Trasparente Certificato alimentare CE
- Durezza Shore: SH 60
- Materiale: Silicone



Riferimento variante:
1 33NI A

- Colore: Nero
- Durezza Shore: SH50
- Materiale: Nitrile



Riferimento variante:
1 33NR A

- Colore: Grigio
- Durezza Shore: SH50
- Materiale: Gomma naturale

Prodotti correlati:

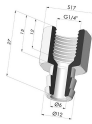

**Inserto a resca
Femmina G1/4"**

Riferimento prodotto: D

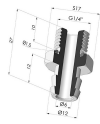

**Inserto a resca
Maschio G1/4"**

Riferimento prodotto: E

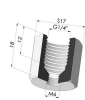

**Adattatore -
Femmina G1/4" -
Femmina M6**

Riferimento prodotto:
F14F6



**Adattatore -
Femmina G1/8" -
Femmina M6**

Riferimento prodotto:
F18F6

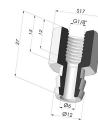

**Inserto a resca
Femmina G1/8"**

Riferimento prodotto: H

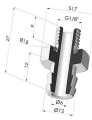

**Inserto a resca
Maschio G1/8"**

Riferimento prodotto: I

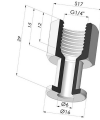

**Inserto Rivettato
Femmina G1/4"**

Riferimento prodotto: L

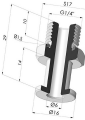

**Inserto Rivettato
Maschio G1/4"**

Riferimento prodotto: M



**Adattatore -
Maschio G1/8" -
Femmina G1/8"**

Riferimento prodotto:
M14F6



**Adattatore -
Maschio G1/8" -
Femmina M6**

Riferimento prodotto:
M18F6



**Vite M5 - ØTesta
14MM - L 20.5MM**

Riferimento prodotto:
M5



**Vite M6 - ØTesta
14MM - L 20.5MM**

Riferimento prodotto:
M6



**Inserto Rivettato
Femmina G1/8"**

Riferimento prodotto: R



**Inserto Rivettato
Maschio G1/8"**

Riferimento prodotto: S



**Vite M8 - ØTesta
14MM - L 20MM**

Riferimento prodotto:
M8T14L20.5