

**TECHNISCHE INFORMATIONEN**

- Balgen :** 0.5 Faltenbalg
- Federweg :** 2 mm
- Form :** Flach
- Höhe :** 10
- Horizontalkraft :** 33 N
- Kategorie :** Flach
- Lippendurchmesser :** 32
- Rohrinnendurchmesser :** 5
- Serie :** 90
- Sortiment :** Sauggreifer
- Vertikalkraft :** 17 N

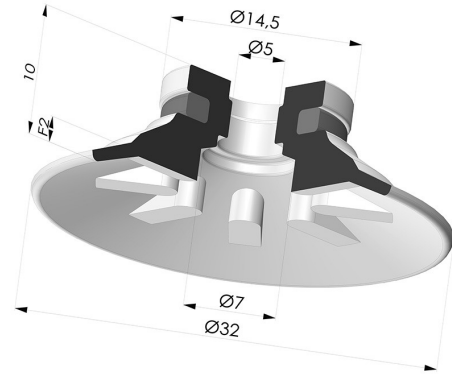

**Varianten:**



Variantenreferenz:

**90 30PU A**

- Farbe: Blau
- Materiale: Polyurethan
- Shore-Härte: SH60



Variantenreferenz:

**90 30SL A**

- Farbe: Rot
- Materiale: Silikon (Lebensmittelszertifikat)
- Shore-Härte: SH60



Variantenreferenz:

**90 30SLT A**

- Farbe: Transparent
- Materiale: Silikon (Lebensmittelszertifikat)
- Shore-Härte: SH60



Variantenreferenz:

**90 30TPU A**

- Farbe: Traspant
- Materiale: Thermoplastisch
- Shore-Härte: SH60

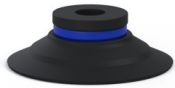





Variantenreferenz:

**90 30NI A**

- Farbe: Schwarz
- Materiale: Nitril
- Shore-Härte: SH50

**Werkstoffleitfaden:**

	Material	Code	Temperatur beständigkeit (°C)	Flexibilität	Abrieb festigkeit	UV/Witterungs beständigkeit	Ölbeständigkeit	Lebensmittel verträglichkeit
	Silikon Rot (Lebensmittelszertifikat)	SL	-60/+250	✓✓✓	✗	✓✓✓	✗	FDA  **
	Silikon Transparent (Lebensmittelszertifikat)	SLT	-60/+250	✓✓✓	✗	✓✓✓	✗	FDA  **
	Nitril Schwarz	NI	-10/+80	✓	✓	✗	✓✓	✗

