

TECHNISCHE INFORMATIONEN

- Balgen :** 1,5 Falten
- Federweg :** 10 mm
- Form :** 1,5 Falten
- Höhe :** 23
- Horizontalkraft :** 32 N
- Kategorie :** Falten
- Lippendurchmesser :** 30 mm
- Massen :** 4 g
- Rohrinnendurchmesser :** 8 mm
- Serie :** 1
- Sortiment :** Sauggreifer
- Vertikalkraft :** 16 N
- Volume :** 4.85 cm³

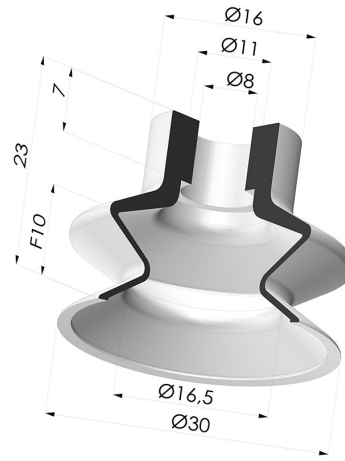

Varianten:

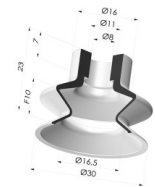

Variantenreferenz:
1 30MNT A

- Farbe: Bordeaux
- Materiale: Abdruckfreies Silikon
- Shore-Härte: SH60



Variantenreferenz:
1 30PU A

- Farbe: Blau
- Materiale: Polyurethan
- Shore-Härte: SH60



Variantenreferenz:
1 30SLT A

- Farbe: Transluzent (Lebensmittels zertifikat)
- Materiale: Silikon
- Shore-Härte: SH60



Variantenreferenz:
1 30SLV A

- Farbe: Grün (Lebensmittels zertifikat)
- Materiale: Silikon
- Shore-Härte: SH60



Variantenreferenz:
1 30NI A

- Farbe: Schwarz
- Materiale: Nitril
- Shore-Härte: SH50

Werkstoffleitfaden:





	Material	Code	Temperatur beständigkeit (°C)	Flexibilität	Abrieb festigkeit	UV/Witterungs beständigkeit	Ölbeständigkeit	Lebensmittel verträglichkeit
	Abdruckfreies Silikon Bordeaux	MNT	-20/+160	✓	✓	✓✓✓	✓✓✓	✗
	Polyurethan Blau	PU	-20/+80	✓	✓✓✓	✓✓	✓✓	✗
	Silikon Transluzent (Lebensmittels zertifikat)	SLT	-60/+250	✓✓✓	✗	✓✓✓	✗	FDA **

	Silikon Grün (Lebensmittels zertifikat)	SLV	-60/+250	✓✓✓	✗	✓✓✓	✗	FDA  **
	Nitril Schwarz	NI	-10/+80	✓	✓	✗	✓✓	✗

Anfragen nach FDA- und/oder EG-Bescheinigungen müssen UNBEDINGT bei der Bestellung erfolgen. Eine nachträgliche Anfrage verursacht zusätzliche Kosten. Um den Erwartungen unserer Industriekunden gerecht zu werden, bietet NOVACOM die größte Auswahl an Elastomer- und Thermoplast-Werkstoffen. Wir können auch neue Werkstoffe nach einem präzisen Lastenheft entwickeln, um spezielle Anwendungen unserer Kunden zu lösen.

 Hervorragend |
  Gut |
  Gering |
  Schlecht |
  Nicht empfohlen
 *Eine FDA- und/oder EG-Bescheinigung kann für verschiedene Referenzen bei der Bestellung angefragt werden; bitte kontaktieren Sie uns.
 ** Lebensmittelkontakt-Zertifizierung: (EG) 1935/2004 - (FDA) 21 CFR 177.2600
 *** Lebensmittelkontakt-Zertifizierung: (EG) 10/2011 - (FDA) 21 CFR

Ähnliche Produkte:

 Adapter - IG G1/4" - IG M6 Produktreferenz: F14F6	 Adapter - IG 1/8G - IG M6 Produktreferenz: F18F6	 Adapter- AG 1/4G - IG M6 Produktreferenz: M14F6	 Adapter- AG 1/8G - IG M6 Produktreferenz: M18F6	 Schraube M6 - ØKopf 11MM - L 17MM Produktreferenz: M6M25
--------------------------------------------------------------------------------------------------------------------------------------------------	-------------------------------------------------------------------------------------------------------------------------------------------------	------------------------------------------------------------------------------------------------------------------------------------------------	--------------------------------------------------------------------------------------------------------------------------------------------------	-----------------------------------------------------------------------------------------------------------------------------------------------------------